

LIGHTING CHANNEL CATALOGUE



ABOUT LBY AFRICA

For over 20 years, LBY LED has been developing and leading the way in LED lighting for the signage and architectural lighting industries.

Our Expertise

Focused on developing, manufacturing and marketing LED products, LBY LED has been setting the standard since 2004.

Global Reach, Local Expertise

The LBY network spans over 120 countries. We take pride in being more than a global entity; we're your local lighting experts.

LBY Africa: Where Brilliance Begins

We bring you a comprehensive range of LED Modules, LED Strips, Power Supplies and Lighting Profiles. Experience the brilliance of LBY LED.



INDEX

- 1 | ALUMINIUM PROFILES
- 2 | SILICONE PROFILES
- 3 | ACCESSORIES





Elevate your lighting design with our exquisite range of Aluminium Profiles for LED Strip lighting. These versatile profiles seamlessly integrate into floors, ceilings, tiles and walkways, providing a sophisticated touch to your space.

Our Aluminum Profiles offer attractive linear lighting and outlining, as well as providing heat management and a protective housing for LED strips. Their simplicity, practicality and elegance make them the perfect choice for your lighting needs.

ECO-L001

RECESSED PROFILE



Specifications

Size:	25.7 x 7mm
Finish:	Silver Anodised or Black
Cover:	PC Opal or Black
Light source width:	12mm
Length:	3 meters
Accessories:	End caps and clips

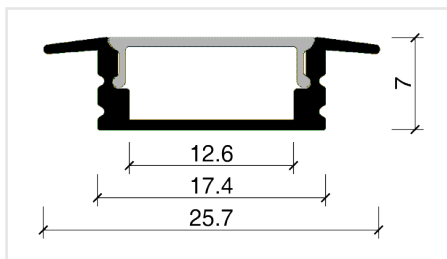

ECO-L002

SURFACE MOUNTED PROFILE



Specifications

Size:	17.2 x 6.9mm
Finish:	Silver Anodised or Black
Cover:	PC Opal or Black
Light source width:	12mm
Length:	3 meters
Accessories:	End caps and clips

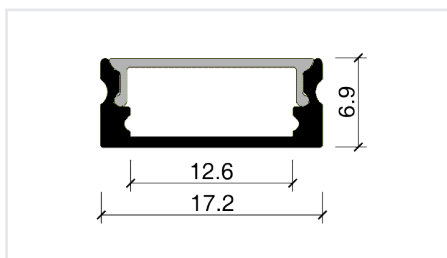

ECO-L205

RECESSED PROFILE



Specifications

Size: 23.6 x 7mm
Finish: Silver Anodised
Cover: PC Opal
Light source width: 12mm
Length: 3 meters
Accessories: End caps and clips

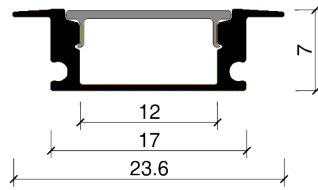

ECO-L204

SURFACE MOUNTED PROFILE



Specifications

Size: 17 x 7mm
Finish: Silver Anodised
Cover: PC Opal
Light source width: 12mm
Length: 3 meters
Accessories: End caps and clips

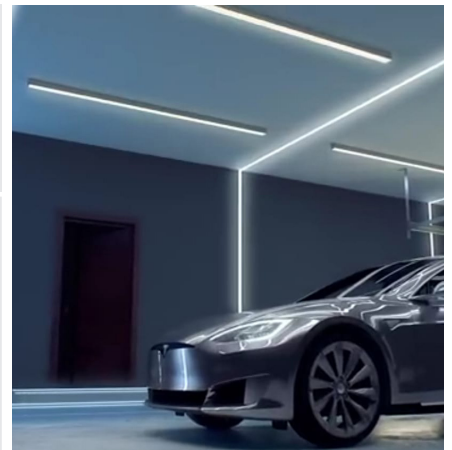
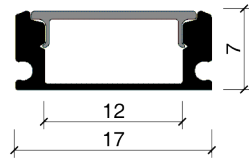

ECO-L1806

SURFACE MOUNTED PROFILE



Specifications

Size: 18 x 4.4mm
Finish: Silver Anodised
Cover: PC Opal
Light source width: 14mm
Length: 3 meters
Accessories: End caps and clips

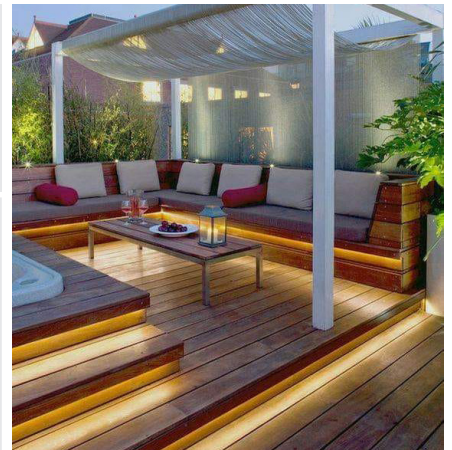
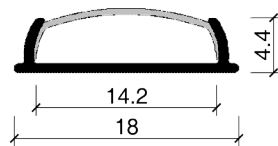

ECO-L1010H-A

RECESSED PROFILE



Specifications

Size: 17 x 10mm
Finish: Silver Anodised
Cover: PC Opal
Light source width: 8mm
Length: 3 meters
Accessories: End caps and clips

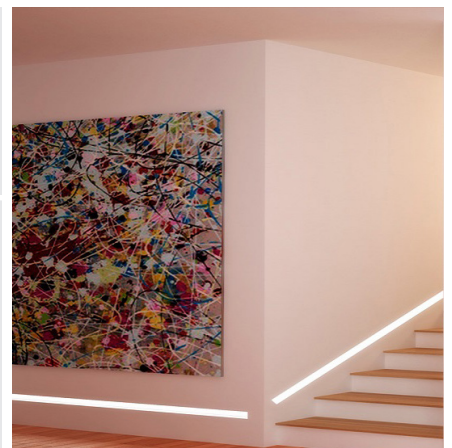
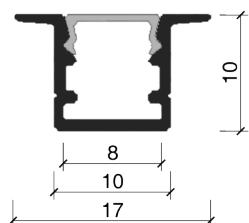

ECO-L1010H-M

SURFACE MOUNTED PROFILE



Specifications

Size: 10 x 10mm
 Finish: Silver Anodised
 Cover: PC Opal
 Light source width: 8mm
 Length: 3 meters
 Accessories: End caps and clips

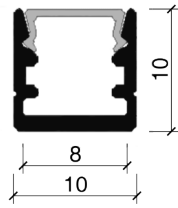

ECO-L512

RECESSED PROFILE



Specifications

Size: 8.7 x 23.7mm
 Finish: Silver Anodised
 Cover: PC Opal
 Light source width: 6mm
 Length: 3 meters
 Accessories: End caps and clips

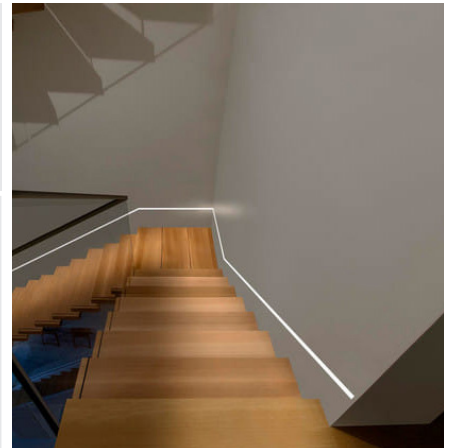
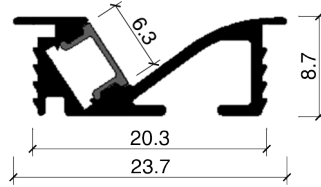

ECO-L005

CORNER SURFACE MOUNTED PROFILE



Specifications

Size: 15.5 x 15.5mm
 Finish: Silver Anodised
 Cover: PC Opal
 Light source width: 10mm
 Length: 3 meters
 Accessories: End caps and clips

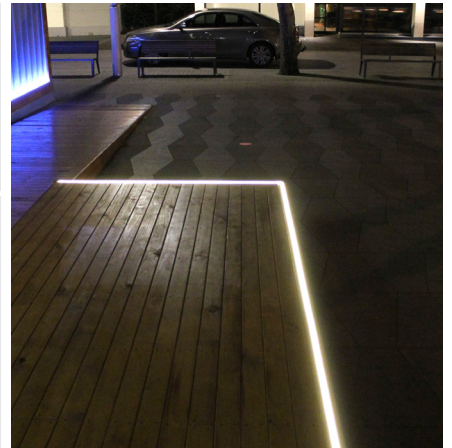
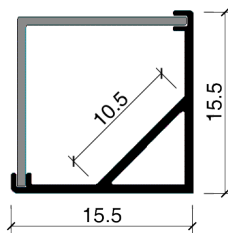

ECO-L006

CORNER SURFACE MOUNTED PROFILE



Specifications

Size: 15.5 x 15.5mm
 Finish: Silver Anodised or Black
 Cover: PC Opal or Black
 Light source width: 10mm
 Length: 3 meters
 Accessories: End caps and clips

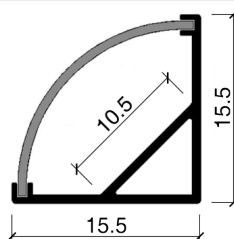

ECO-L007

CORNER SURFACE MOUNTED PROFILE



Specifications

Size: 18 x 18mm
Finish: Silver Anodised
Cover: PC Opal
Light source width: 12mm
Length: 3 meters
Accessories: End caps and clips

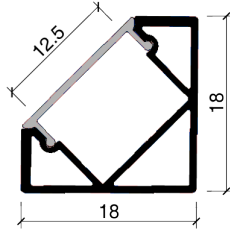

ECO-L016

CORNER SURFACE MOUNTED PROFILE



Specifications

Size: 29.7 x 29.7mm
Finish: Silver Anodised
Cover: PC Opal
Light source width: 20mm
Length: 3 meters
Accessories: End caps and clips

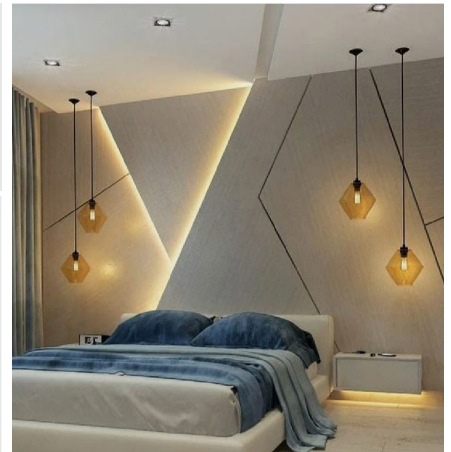
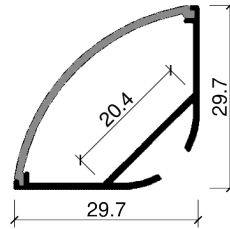

ECO-L003

RECESSED PROFILE



Specifications

Size: 24.2 x 14.3mm
Finish: Silver Anodised
Cover: PC Opal
Light source width: 12mm
Length: 3 meters
Accessories: End caps and clips

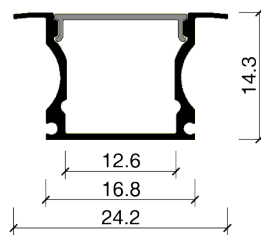

ECO-L004

SURFACE MOUNTED PROFILE



Specifications

Size: 16.8 x 14.3mm
Finish: Silver Anodised
Cover: PC Opal
Light source width: 12mm
Length: 3 meters
Accessories: End caps and clips

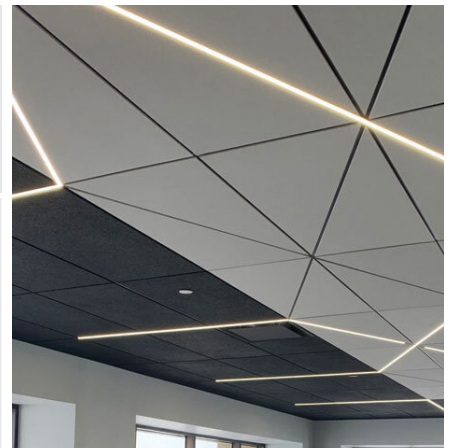
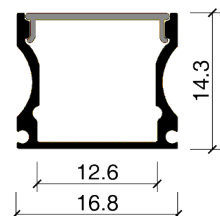

ECO-L013

RECESSED PROFILE



Specifications

Size: 30 x 9.6mm
Finish: Silver Anodised or Black
Cover: PC Opal or Black
Light source width: 21mm
Length: 3 meters
Accessories: End caps and clips

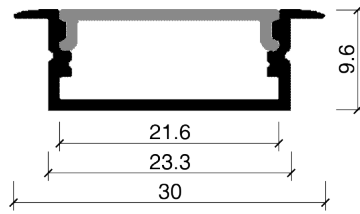

ECO-L014

SURFACE MOUNTED PROFILE



Specifications

Size: 23.3 x 9.6mm
Finish: Silver Anodised or Black
Cover: PC Opal or Black
Light source width: 21mm
Length: 3 meters
Accessories: End caps and clips

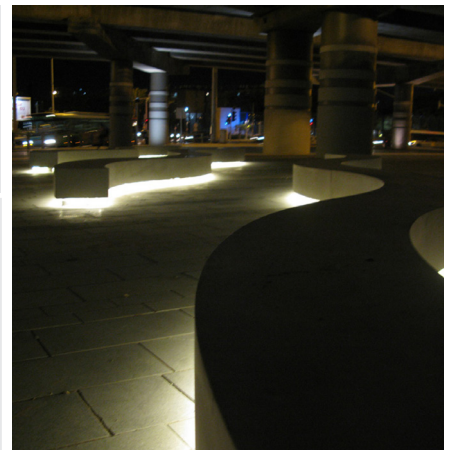
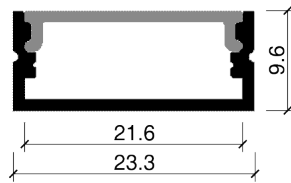

ECO-2320M

SURFACE MOUNTED PROFILE



Specifications

Size: 23 x 20mm
Finish: Silver Anodised
Cover: PC Opal
Light source width: 20mm
Length: 3 meters
Accessories: End caps and clips

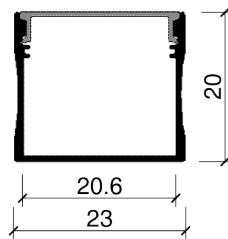

ECO-2320A

RECESSED PROFILE



Specifications

Size: 30 x 20mm
Finish: Silver Anodised
Cover: PC Opal
Light source width: 20mm
Length: 3 meters
Accessories: End caps and clips

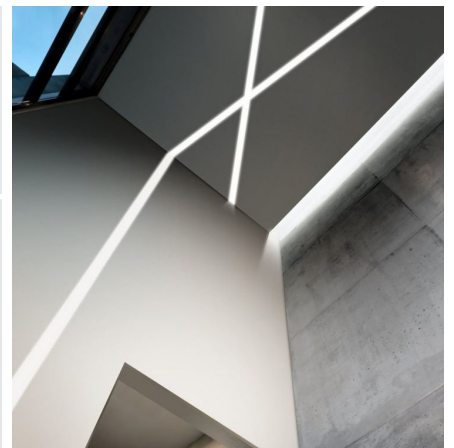
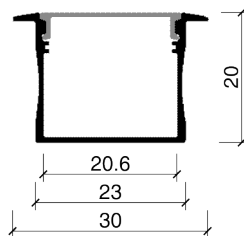

ECO-L018

SURFACE MOUNTED PROFILE



Specifications

Size: 35 x 35mm
Finish: Silver Anodised
Cover: PC Opal
Light source width: 31mm
Length: 3 meters
Accessories: End caps and clips

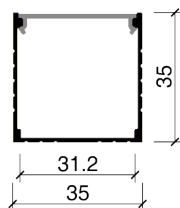

ECO-L017

RECESSED PROFILE



Specifications

Size: 44 x 35mm
Finish: Silver Anodised
Cover: PC Opal
Light source width: 31mm
Length: 3 meters
Accessories: End caps and clips

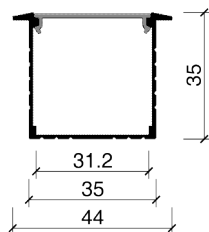

ECO-L051

SUSPENDED PROFILE



Specifications

Size: 50 x 34.7mm
Finish: Silver Anodised
Cover: PC Opal
Light source width: 37mm
Length: 3 meters
Accessories: End caps, clips and suspension cables

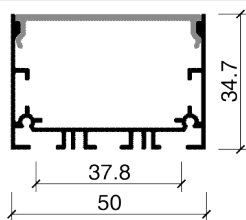

ECO-L053A

RECESSED PROFILE



Specifications

Size: 64 x 34.7mm
Finish: Silver Anodised
Cover: PC Opal
Light source width: 37mm
Length: 3 meters
Accessories: End caps and clips

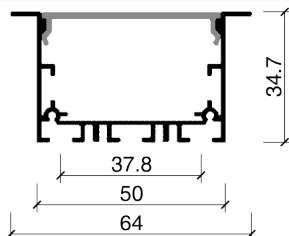

ECO-L053B

RECESSED PROFILE



Specifications

Size: 65 x 34.7mm
Finish: Silver Anodised
Cover: PC Opal
Light source width: 37mm
Length: 3 meters
Accessories: End caps and clips

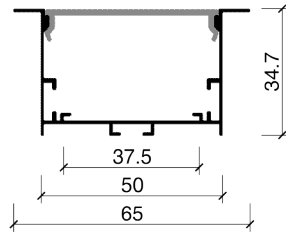

ECO-L111

SUSPENDED PROFILE



Specifications

Size: 45 x 42mm
Finish: Silver Anodised
Cover: PC Opal
Light source width: 34mm
Length: 3 meters
Accessories: End caps, clips and suspension cables

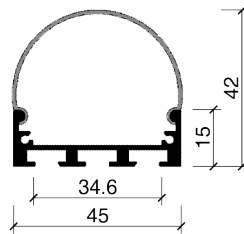

ECO-L069A

SUSPENDED PROFILE



Specifications

Size: 60mm Ø
Finish: Silver Anodised
Cover: PC Opal
Light source width: 30mm
Length: 3 meters
Accessories: End caps, clips and suspension cables

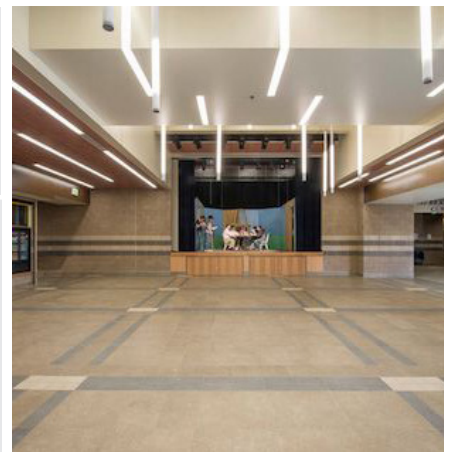
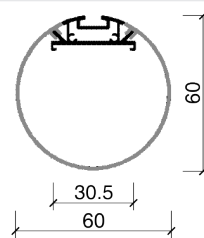

ECO-A017

SUSPENDED PROFILE



Specifications

Size: 50 x 50mm
Finish: Silver Anodised
Cover: PC Opal
Light source width: 37mm
Length: 3 meters
Accessories: End caps, clips and suspension cables

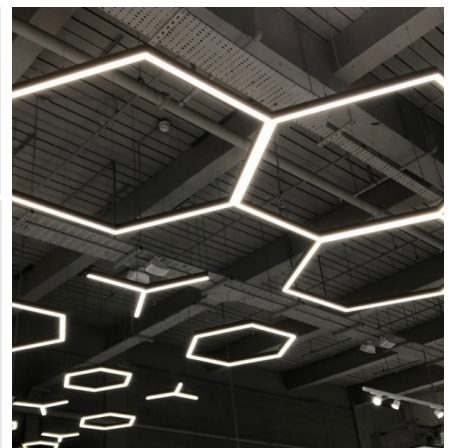
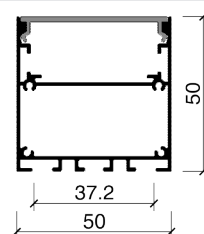

ECO-L7676M

SUSPENDED PROFILE

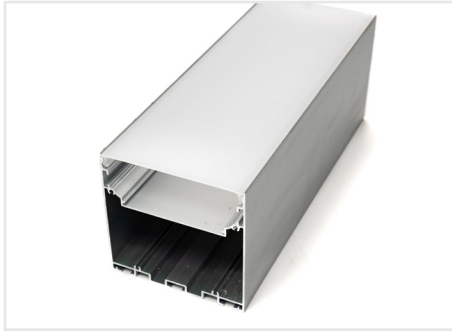

Specifications

Size: 76.2 x 76mm
Finish: Silver Anodised
Cover: PC Opal
Light source width: 55mm
Length: 3 meters
Accessories: End caps, clips and suspension cables

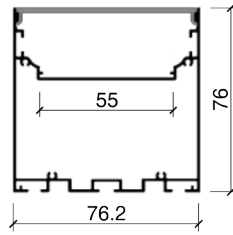

ECO-L001BLK

RECESSED PROFILE



Specifications

Size: 24.7 x 7mm
Finish: Black
Cover: PC Black
Light source width: 12mm
Length: 3 meters
Accessories: End caps and clips

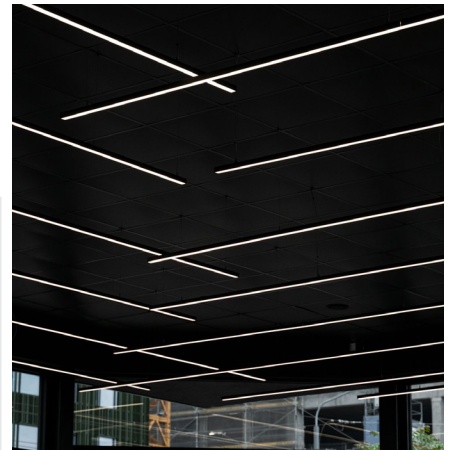
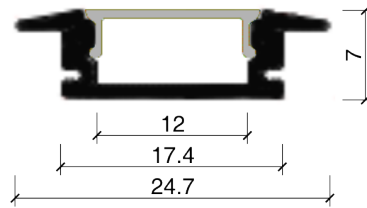

ECO-L002BLK

SURFACE MOUNTED PROFILE



Specifications

Size: 17.4 x 7mm
Finish: Black
Cover: PC Black
Light source width: 12mm
Length: 3 meters
Accessories: End caps and clips

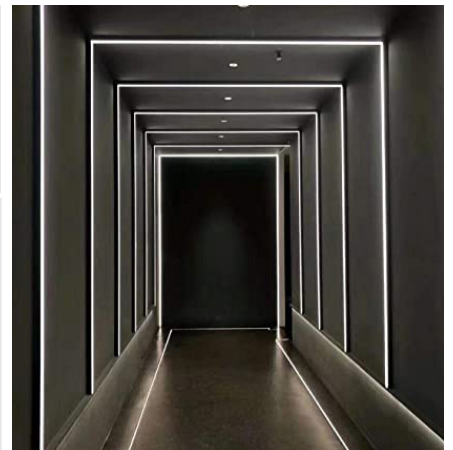
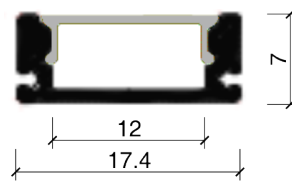

ECO-L006BLK

CORNER SURFACE MOUNTED PROFILE



Specifications

Size: 15.5 x 15.5mm
Finish: Black
Cover: PC Black
Light source width: 10mm
Length: 3 meters
Accessories: End caps and clips

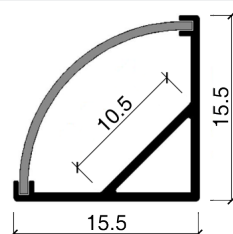

ECO-L013BLK

RECESSED PROFILE



Specifications

Size: 30 x 9.6mm
 Finish: Black
 Cover: PC Black
 Light source width: 21mm
 Length: 3 meters
 Accessories: End caps and clips

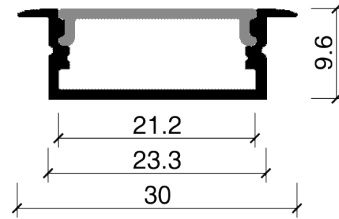

ECO-L014BLK

SURFACE MOUNTED PROFILE



Specifications

Size: 23.3 x 9.6mm
 Finish: Black
 Cover: PC Black
 Light source width: 21mm
 Length: 3 meters
 Accessories: End caps and clips

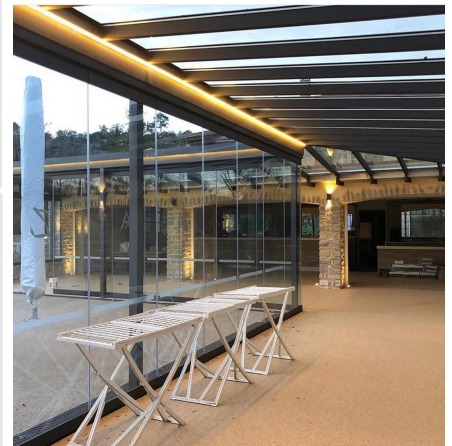
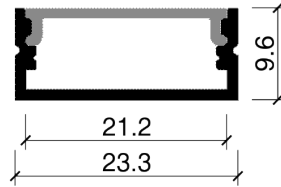

ECO-A018BLK

SUSPENDED PROFILE



Specifications

Size: 50 x 75mm
 Finish: Black
 Cover: PC Opal
 Light source width: 26mm
 Length: 3 meters
 Accessories: End caps, clips, tracks suspension cables

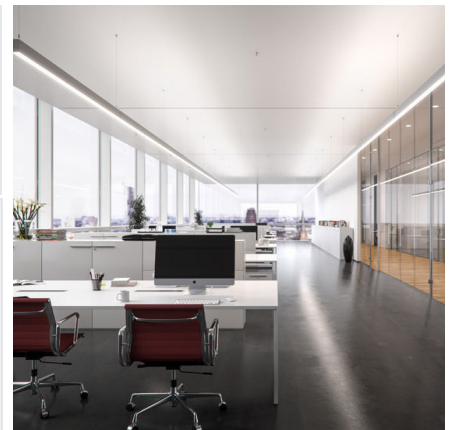
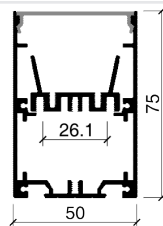

ECO-L048

RECESSED FLOOR PROFILE



Specifications

Size: 27.1 x 11.3mm
 Finish: Silver Anodised
 Cover: PC Opal
 Light source width: 12mm
 Length: 3 meters
 Accessories: End caps and clips

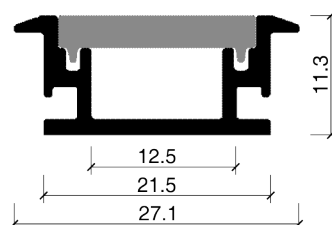

ECO-L404L

SURFACE MOUNTED PROFILE

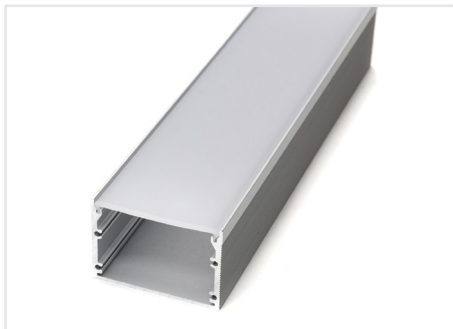

Specifications

Size: 50 x 35mm
 Finish: Silver Anodised
 Cover: PC Opal
 Light source width: 46mm
 Length: 3 meters
 Accessories: End caps and clips

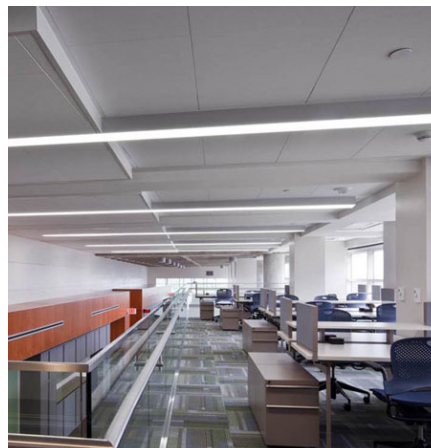
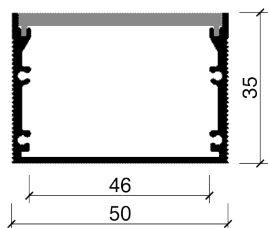

ECO-L040L

SURFACE MOUNTED UP AND DOWN PROFILE



Specifications

Size: 50 x 17mm
 Finish: Silver Anodised
 Cover: PC Opal
 Light source width: 12mm
 Length: 3 meters
 Accessories: End caps and clips

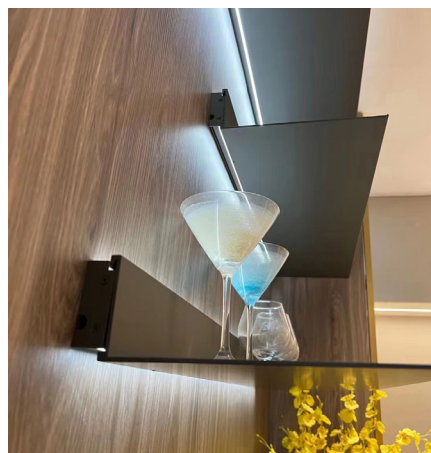
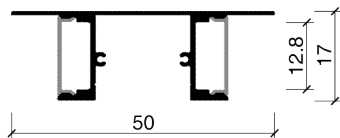

ECO-L516

STAIR EDGE PROFILE



Specifications

Size: 65.6 x 26.9mm
 Finish: Silver Anodised
 Cover: PC Opal
 Light source width: 12mm
 Length: 3 meters
 Accessories: End caps and clips

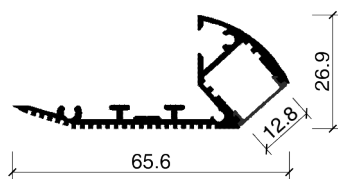

ECO-L515

RECESSED SKIRTING PROFILE



Specifications

Size: 71.4 x 13.4mm
 Finish: Silver Anodised
 Cover: PC Opal
 Light source width: 11mm
 Length: 3 meters
 Accessories: End caps and clips

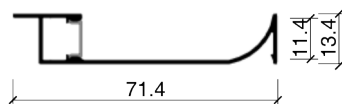

ECO-L503

SURFACE MOUNTED SKIRTING PROFILE



Specifications

Size: 60 x 15.4mm
Finish: Silver Anodised
Cover: PC Opal
Light source width: 10mm
Length: 3 meters
Accessories: End caps and clips

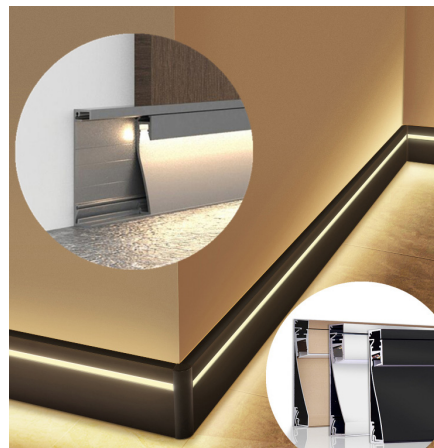
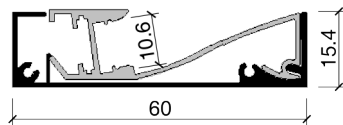

ECO-L305

RECESSED WALL AND CEILING PROFILE



Specifications

Size: 66.7 x 13.8mm
Finish: Silver Anodised
Cover: PC Opal or Black
Light source width: 20mm
Length: 3 meters
Accessories: End caps and clips

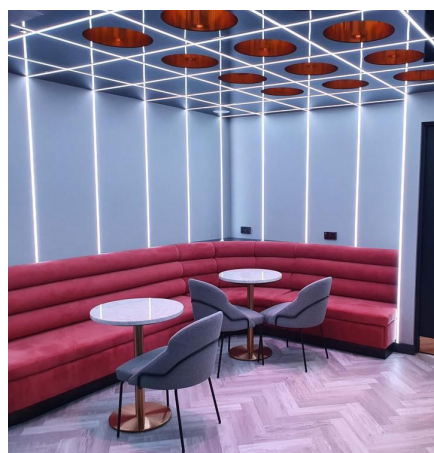
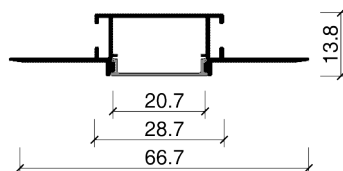

ECO-L311

RECESSED WALL AND CEILING PROFILE



Specifications

Size: 19 x 38.4mm
Finish: Silver Anodised
Cover: PC Opal
Light source width: 14mm
Length: 3 meters
Accessories: End caps and clips

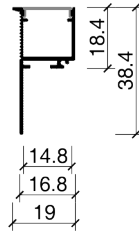



12 SILICONE PROFILES

Innovate with our state-of-the-art Silicone Profiles for LED Strip lighting. Offering an abundance of options for your lighting designs with various shapes and sizes; these profiles can be recessed, surface mounted or suspended.

Our Silicone Profiles provide unparalleled flexibility, with a sleek and stunning finish. Unleash your creativity and illuminate your space with style.

LBY-SIL-1212

SURFACE MOUNTED PROFILE



Specifications	
Size:	12 x 12mm
PCB width:	8mm
Colour:	White and Opal
Beam angle:	120°
Lighting direction:	Top
Weight:	111 g/m
Cutting Marks:	Yes

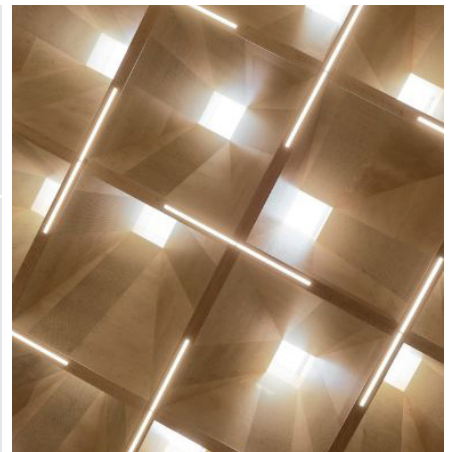
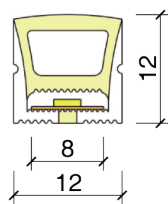

LBY-SIL-2020

SURFACE MOUNTED PROFILE

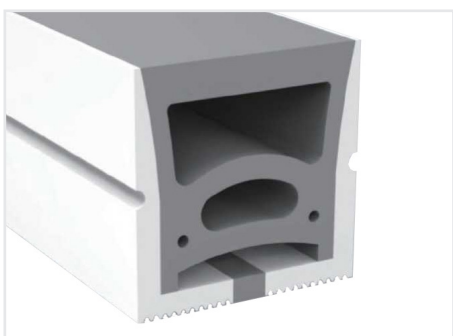

Specifications	
Size:	20 x 20mm
PCB width:	10 or 12mm
Colour:	Opal and White
Beam angle:	120°
Lighting direction:	Top
Weight:	336 g/m
Cutting Marks:	Yes

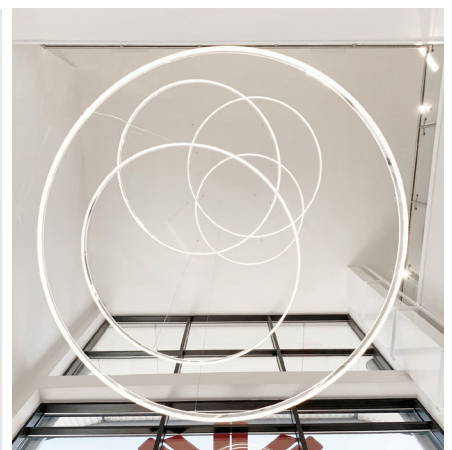
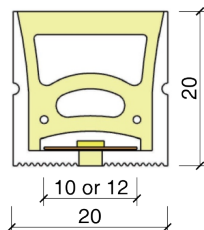

LBY-SIL-3032

SURFACE MOUNTED PROFILE



Specifications

Size:	30 x 32mm
PCB width:	12 or 15mm
Colour:	Opal and White
Beam angle:	120°
Lighting direction:	Side
Weight:	628 g/m
Cutting Marks:	Yes

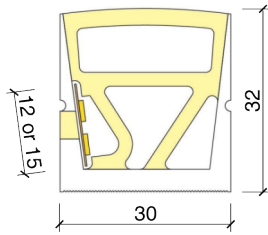

LBY-SIL-2014

SURFACE MOUNTED PROFILE



Specifications

Size:	20 x 14mm
PCB width:	10mm
Colour:	White and Opal
Beam angle:	120°
Lighting direction:	Top
Weight:	218 g/m
Cutting Marks:	Yes

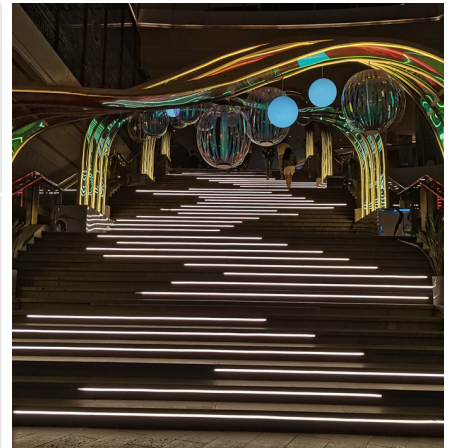
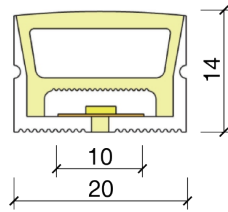

LBY-SILR-1212T

RECESSED PROFILE

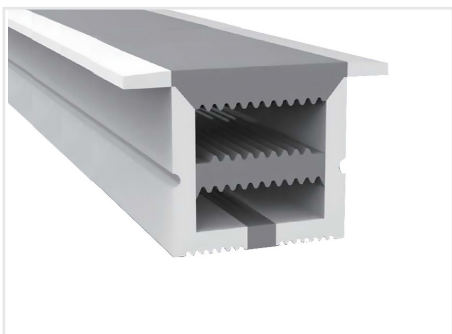

Specifications

Size:	18 x 12mm
PCB width:	8mm
Colour:	Opal and White
Beam angle:	120°
Lighting direction:	Top
Weight:	126 g/m
Cutting Marks:	Yes

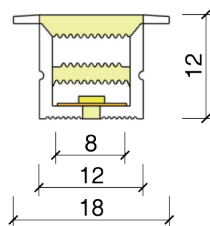

LBY-SILR-1616

RECESSED PROFILE

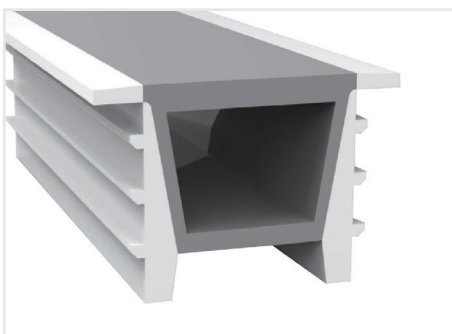

Specifications

Size:	23 x 16mm
PCB width:	8 or 10mm
Colour:	Opal and White
Beam angle:	120°
Lighting direction:	Top
Weight:	151 g/m
Cutting Marks:	Yes

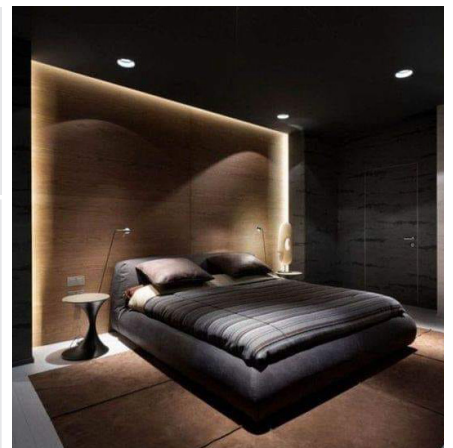
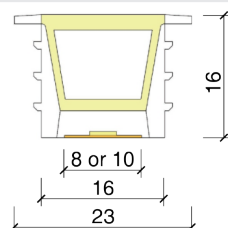

LBY-SIL-0612

SURFACE MOUNTED PROFILE



Specifications

Size: 6 x 12mm
 PCB width: 8mm
 Colour: Opal and White
 Beam angle: 120°
 Lighting direction: Side
 Weight: 71 g/m
 Cutting Marks: Yes

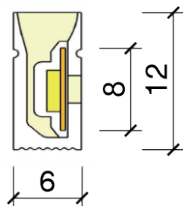

LBY-SIL-1020

SURFACE MOUNTED PROFILE



Specifications

Size: 10 x 20mm
 PCB width: 10mm
 Colour: Opal and White
 Beam angle: 120°
 Lighting direction: Side
 Weight: 190 g/m
 Cutting Marks: Yes

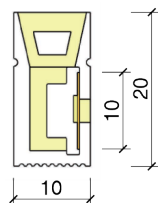

LBY-SIL-1313

SURFACE MOUNTED PROFILE



Specifications

Size: 13 x 13mm
 PCB width: 8mm
 Colour: Opal
 Beam angle: 180°
 Lighting direction: Top
 Weight: 141 g/m
 Cutting Marks: Yes

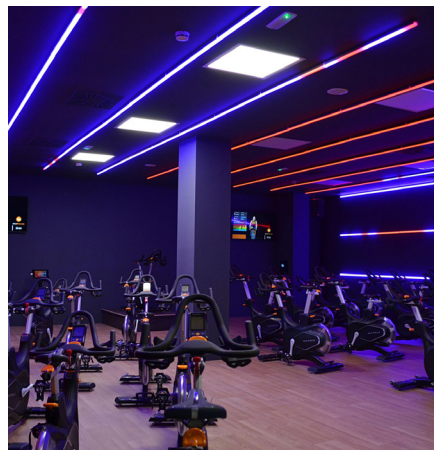
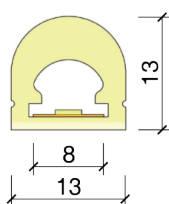

LBY-SIL-1023

RECESSED OR SURFACE MOUNTED PROFILE



Specifications

Size: 10 x 23mm
 PCB width: 10mm
 Colour: Opal and White
 Beam angle: 270°
 Lighting direction: Side
 Weight: 185 g/m
 Cutting Marks: Yes

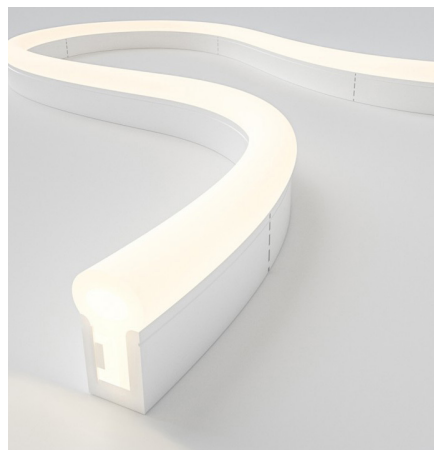
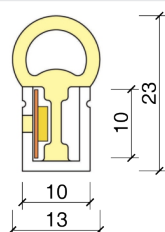

LBY-SIL-0817

RECESSED OR SURFACE MOUNTED PROFILE



Specifications

Size: 8 x 17mm
PCB width: 8mm
Colour: Opal and White
Beam angle: 270°
Lighting direction: Side
Weight: 141 g/m
Cutting Marks: Yes

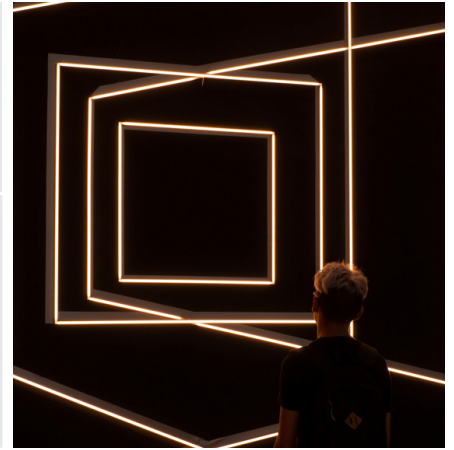
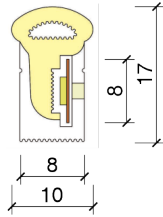

LBY-SIL-1212BL

SURFACE MOUNTED PROFILE

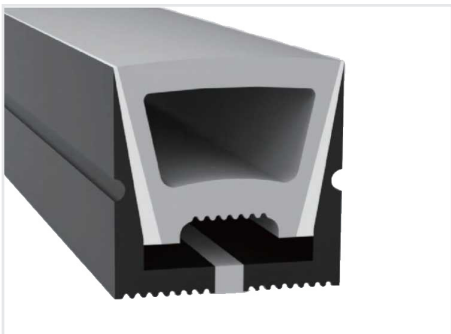

Specifications

Size: 12 x 12mm
PCB width: 8mm
Colour: Opal and Black
Beam angle: 120°
Lighting direction: Top
Weight: 126 g/m
Cutting Marks: Yes

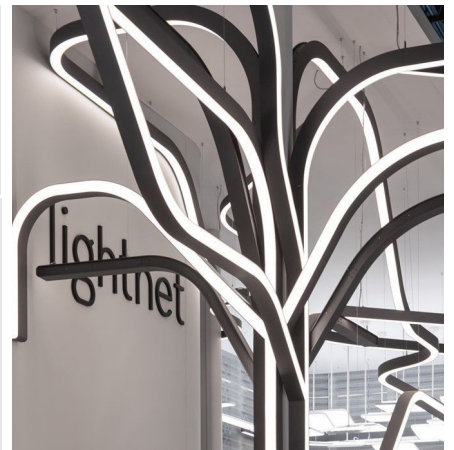
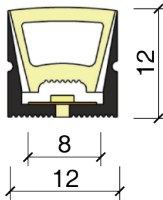

LBY-SIL-1616BL

SURFACE MOUNTED PROFILE

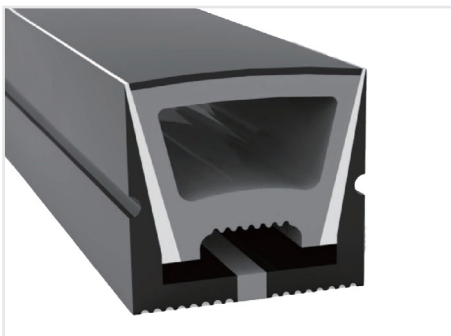

Specifications

Size: 16 x 16mm
PCB width: 10mm
Colour: Opal and Black
Beam angle: 120°
Lighting direction: Top
Weight: 192 g/m
Cutting Marks: Yes

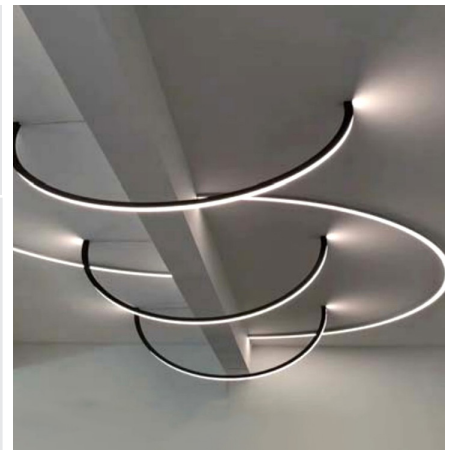
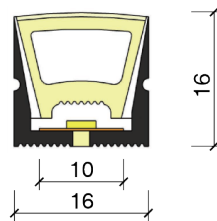

LBY-SIL-1220BL

SURFACE MOUNTED PROFILE



Specifications

Size: 12 x 20mm
PCB width: 10mm
Colour: Opal and Black
Beam angle: 120°
Lighting direction: Side
Weight: 220 g/m
Cutting Marks: Yes

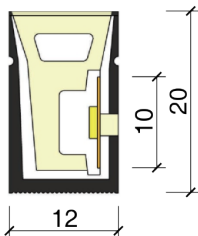

LBY-SIL-1212TBL

RECESSED PROFILE



Specifications

Size:	18 x 12mm
PCB width:	8mm
Colour:	Opal, Black and White
Beam angle:	120°
Lighting direction:	Top
Weight:	115 g/m
Cutting Marks:	Yes

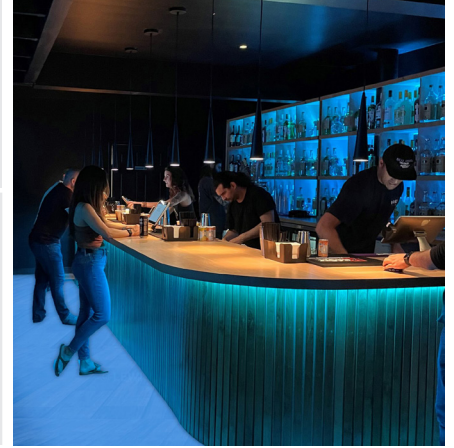
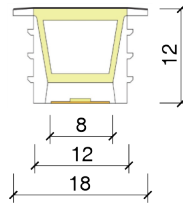

LBY-SIL-D20

SURFACE MOUNTED PROFILE



Specifications

Size:	20mm Ø
PCB width:	10mm
Colour:	Opal
Beam angle:	270°
Lighting direction:	Top
Weight:	313 g/m

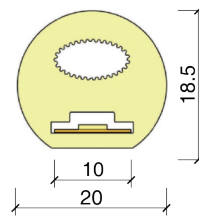

LBY-SIL-D33

360° LOOP LIGHT



Specifications

Size:	33mm Ø
PCB width:	8mm double sided
Colour:	Opal
Beam angle:	360°
Lighting direction:	360°
Weight:	350 g/m

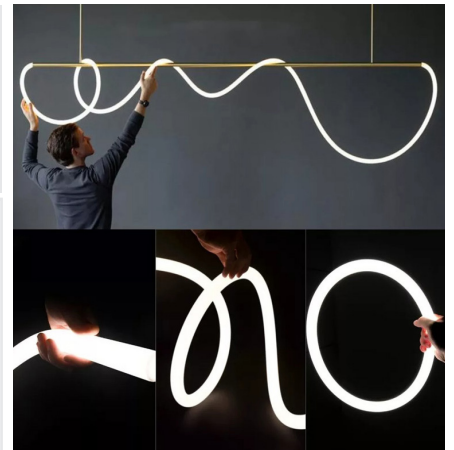
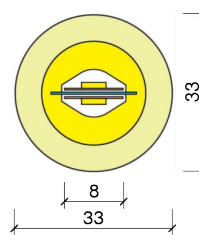

LBY-SIL-D40

360° LOOP LIGHT



Specifications

Size:	40mm Ø
PCB width:	10mm double sided
Colour:	Opal
Beam angle:	360°
Lighting direction:	360°
Weight:	1309 g/m

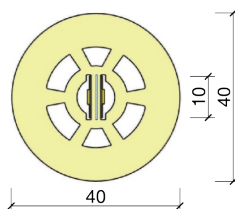





| 3

ACCESSORIES

END CAPS

For use with all aluminium and silicone profiles.



• White end caps for aluminium

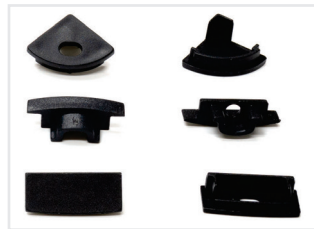

• Black end caps for aluminium



• Aluminium plates for aluminium

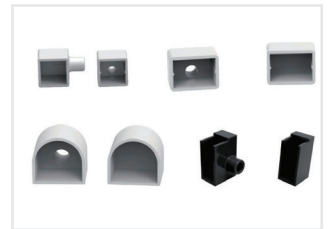

• Plastic end caps for silicone

CLIPS AND TRACKS

Clips for all aluminium and silicone profiles.
Channels and flexible tracks for silicone profiles only.

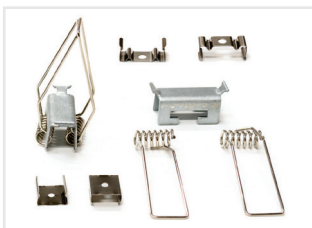

• Clips for recessed profiles



• Clips for surface mounting

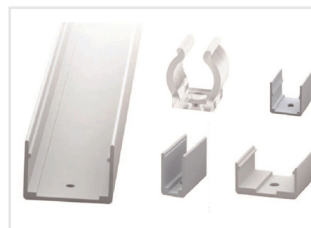

• Channels and clips for silicone profiles



• Tracks for silicone profiles



JOINERS

For use in all aluminium profiles.



• Straight connector



• Connector for internal corners



• Connector for external corners



• Y connector

SUSPENSION CABLES

For use with all suspended aluminium profiles.



• Large single end



• Large double end



• Small end



• Ball end



+27 11 824 3270

admin@lbyafrica.com

www.lbyafrica.com

Johannesburg - Cape Town - Durban